

Pre-installation/Installation

Wall Drinking aquaBUBBLER

Product Codes: ABWD22

★ IMPORTANT >>>

Unit must be installed by a Certified Plumber



- failure to do so will void all warranties.

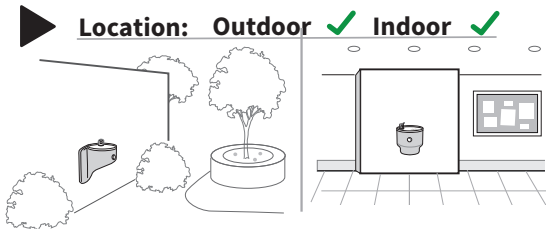

Identify Water Inlet & Waste Water Outlet Points

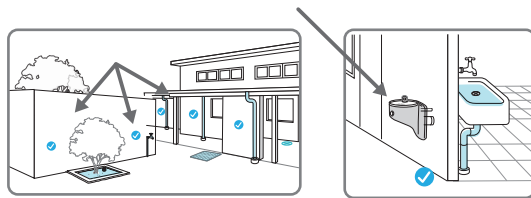

Install onto :

Solid/ Brick Wall

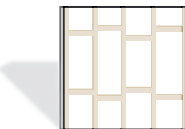
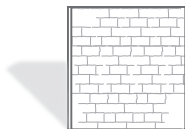

Prepare Connection Points for installation

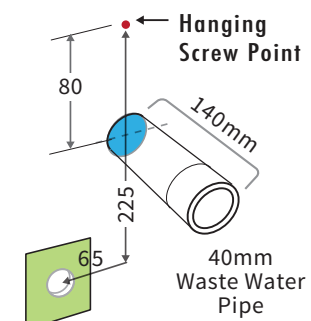

Use Hanging Screw point (50mm below the desired height of the wall drinking dish) as reference to prepare the location of **Water Outlet** and **Water Inlet**

More Details on Schematic >

Area available for Water Supply - 17x17mm (1/2" BSP)

1 Disassemble Wall Bracket from Lid & Moulded Body

- Lay unit on its back on a table. Remove 4 x Security Screws around the Stainless Steel lid with the T30 Post Torx Screwdriver (supplied).

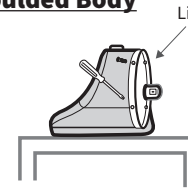

- Lift the lid slightly away from the moulded body. Disconnect the water dispenser supply line by holding back the **grey collet ring** on the bottom of the water dispenser and pulling out the black tubing.

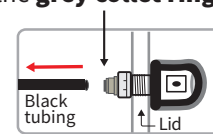

- After disconnect the lid, remove 4 x PH screws to release unit body from the internal wall bracket.

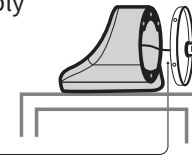

- Lift the moulded body off internal wall bracket.

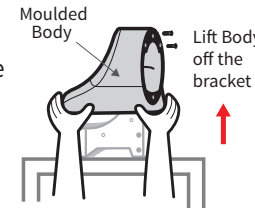

2 Set up Hanging Screw & Connection Points

Consult SCHEMATIC, mark other connection points referencing the Hanging Screw (Leave head off wall surface for 2mm)

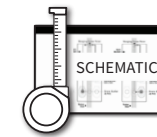

[DOWNLOAD Schematic >>>](#)

3 Connect Waste Water Outlet

Fit off the mini P-trap (supplied) to the end of the waste water pipe with **Sealant**.

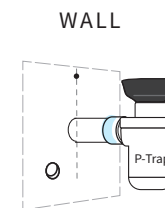

4 Hang up Unit

Hang unit on wall over the Hanging Screw. Place the internal bracket over the mini P-trap and locate the keyhole onto the hanging screw. Use a **spirit level** to set the position of bracket to the wall.

Anchor unit to wall with Screws (at least 4 corners).

- Solid wall - screws + green plugs (supplied) along sides
- Stud wall - Tek screws (supplied) along centre into timber stud

5 Connect Water Inlet

Connect water inlet to 1/2" BSP connection, isolation valve and variable flow/pressure regulator.

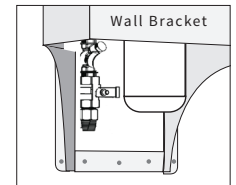

6 Reassemble Moulded Body & Lid to Wall Bracket

- Slide moulded body over bracket to the wall.
- Secure in place by re-screwing in the 4 x PH screws.

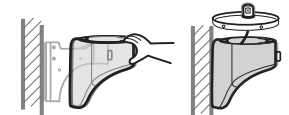

- Refit black tubing by pushing straight back into the bottom of the water dispenser with the lid.
- Rescrew 4 x Security screws around the lid.

7 Finishing

Run tap and check for leaks →



8 Before You Go

Leave T30 Post Torx Security Screwdriver with client

