

★ IMPORTANT >>>

Unit must be installed by a Certified Plumber



- failure to do so will void all warranties.

1 Location: Outdoor ✓ Indoor ✓

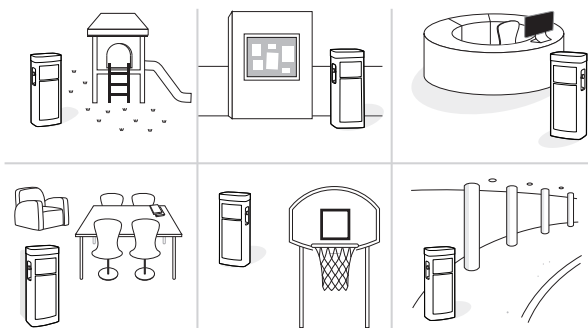

Install onto :

2 Ground Work ✓ Concrete Pad ✓ Timber Floor ✓

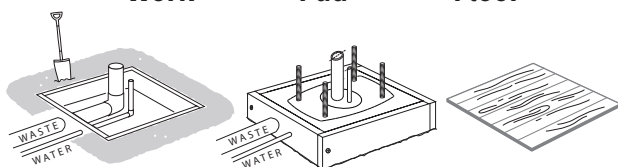

3 Determine Plumbing Connection

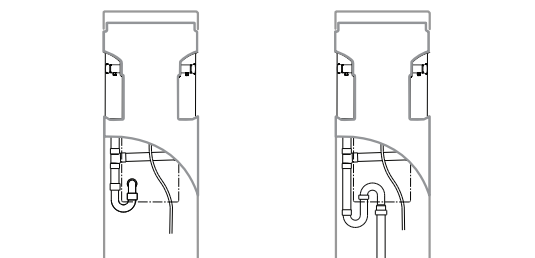

Above Ground

Below Ground

4 Identify Water & Drainage points

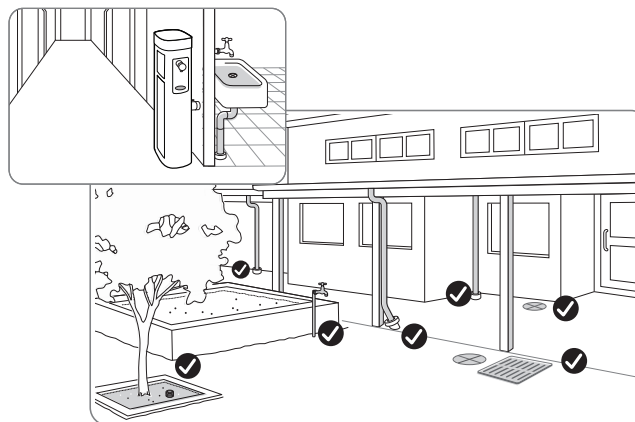

5 Is an Anti-Freeze Valve Required?

Where installed in frost-prone areas, unit must be fitted with an Anti-Freeze Valve. Warranty will otherwise be void

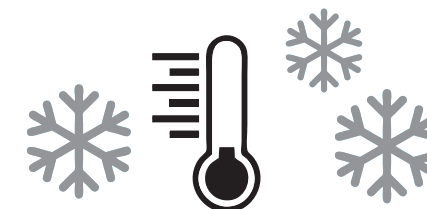

6 Plumbing Tools Required

- 1 Timber boxing foundation
- 2 Screws and washers
- 3 Bag of cement
- 4 Socket Extension Bar
- 5 10 mm threaded rod and nuts
- 6 Flexible head ratchet wrench
- 7 43 mm hole saw
- 8 15 mm hole saw
- 9 10 mm socket

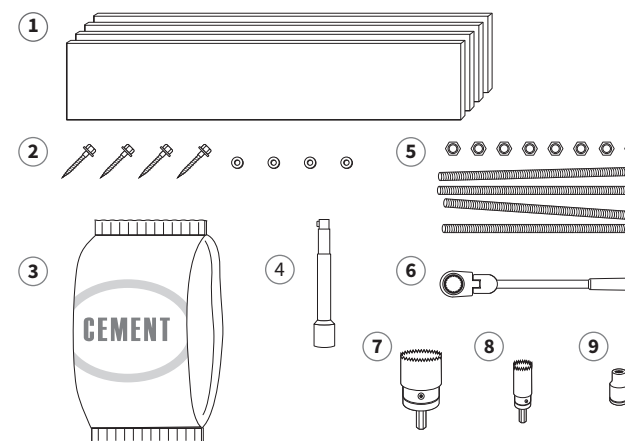

ATTENTION PLUMBER: See next page for INSTALLATION GUIDE



★ IMPORTANT >>>

Unit must be installed by a Certified Plumber



- failure to do so will void all warranties.

1 Consult Schematic

Mark measurements and dimensions as indicated by Schematic:

Twin Refill ABS14 ▶

Schematic is also available for download from our website

2 Expose Access Panel

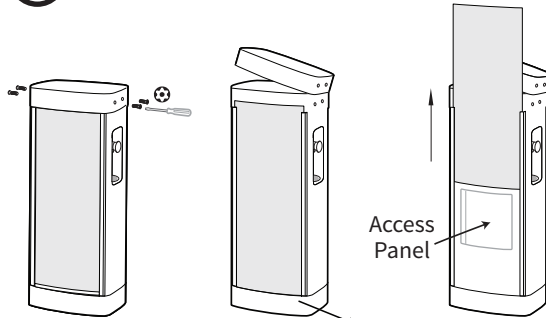

Remove lid with T30 Post Torx Security Screwdriver (supplied)

Remove aluminium strip at base to ease movement
Slide poster up to expose Access Panel

3 Locate Internal Base Mounting Plate

- Place Base Mounting Plate in position on the installation surface.
- Mark anchor points on the surface through BMP holes & drill out.
- Fit off either 12 mm threaded rods or 16mm dynabolts*
- Gain access to the base of the unit via Access Panel.
- Place unit over anchors, then place the Plate back inside unit over anchors and secure in place.

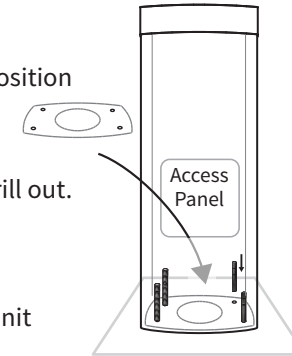

** Indicates correct gauges for anchor system types listed; choice of anchor system is at installer's discretion*

4 Flush out the lines

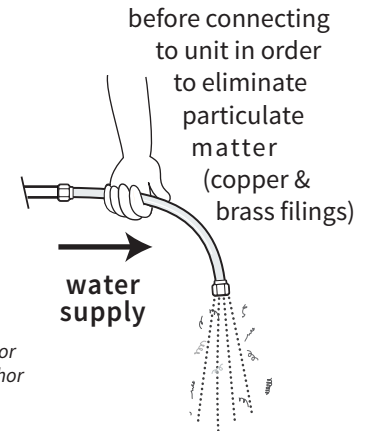

5 Install Isolation Valve (not supplied)

on mains line, external to unit (recommended)

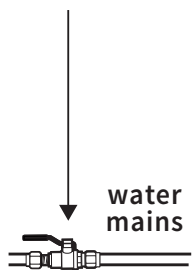

6 Attach DB

Units with Dog Bowl (DB) only

Insert coach bolts through square holes (either side of DB)
Secure bolts from inside of unit with washer and lock nut



7 DON'T FORGET:

Check for leaks

Run taps and adjust any insecure connections.

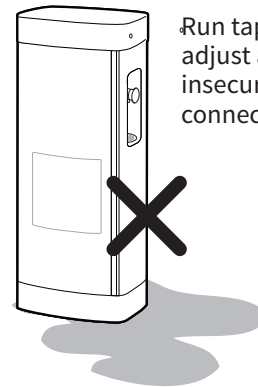

8 SET UP FOR USE:

Adjust water pressure

Rotate keyhole with a 5mm screwdriver to adjust water pressure.

Advise client to check water pressure 48 hours after installation, as it may require re-adjustment.

Leave T30 Post Torx Security Screwdriver with client

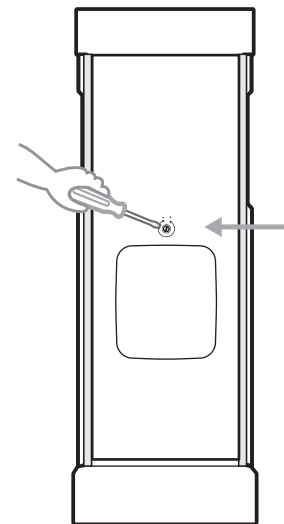

ATTENTION PLUMBER: See previous page for PRE-INSTALLATION GUIDE